

Data sheet | Item number: 286-830

Bridge rectifier module; Input voltage: 24 VAC; with varistor protective circuit; gray

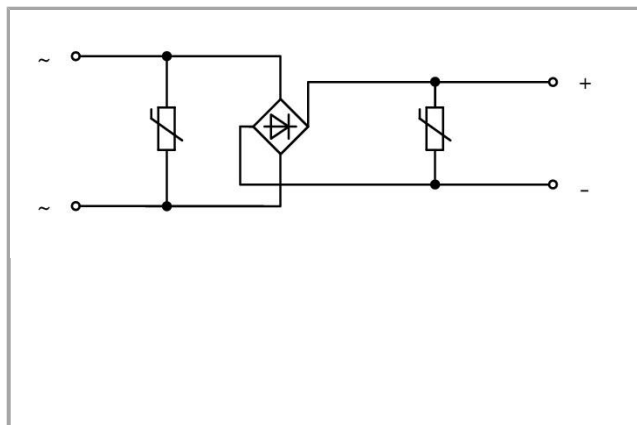

286-830

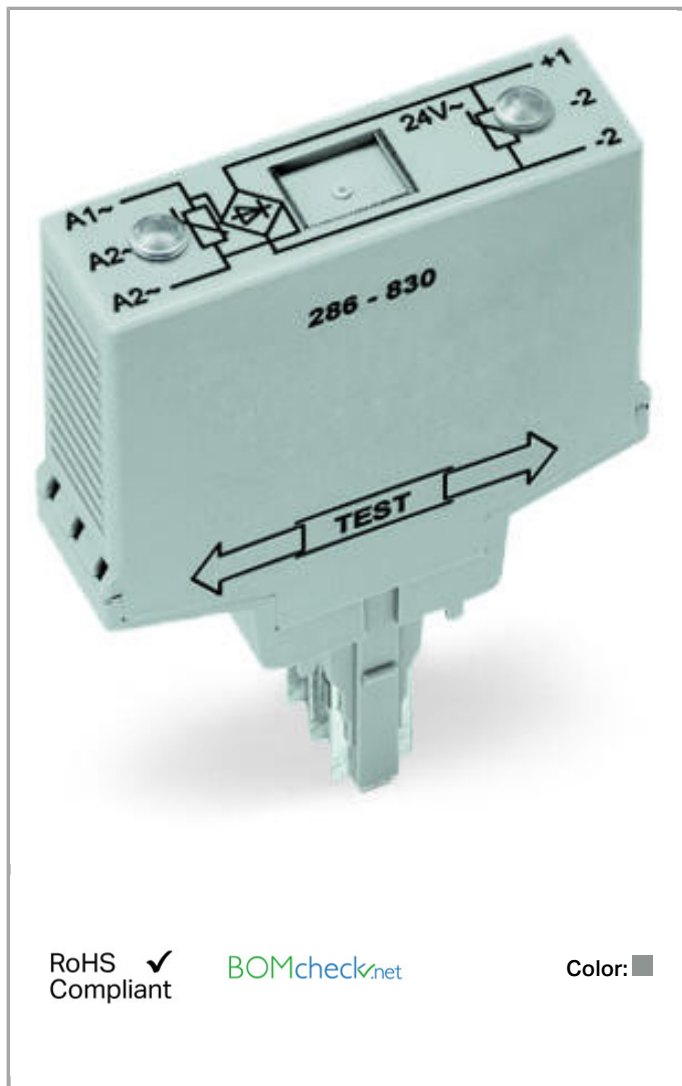

RoHS Compliant

[BOMcheck.net](https://www.bomcheck.net)

Color: ■

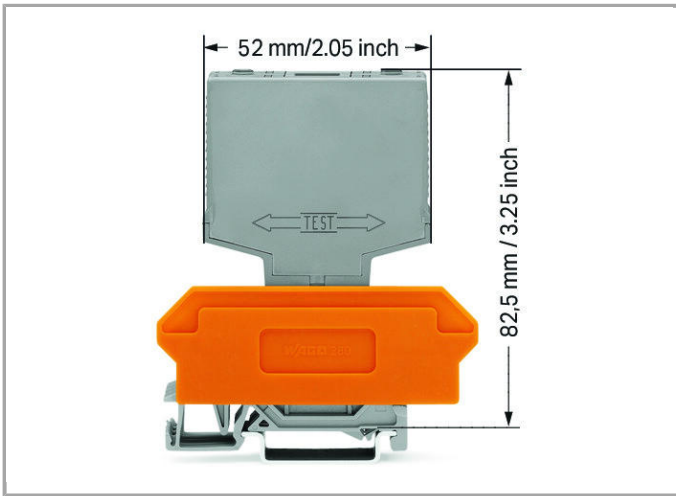

Data

Electrical data

Nominal operating voltage	AC 24 V
Operating voltage	≤ AC 35 V
Current consumption at supply voltage	0
Nominal current	1 A
Switch-on capacity	< 2200 μF

Geometrical Data

Width	15 mm / 0.591 inch
Height from upper-edge of DIN-35 rail	82.5 mm / 3.25 inch
Depth	52 mm / 2.047 inch

Mechanical data

Type of mounting	Pluggable module for carrier terminal blocks
Housing design	Pluggable module for terminal blocks

Material Data

Color	gray
Fire load	0.338 MJ
Weight	21.577 g

Environmental Requirements

Surrounding air (operating) temperature	-25 40 °C
---	-----------









Commercial data

Product Group	6 (Interface Electronics)
---------------	---------------------------



Country of origin	DE
GTIN	4045454549848
Customs Tariff No.	85369010000

Compatible products

Marking accessories

	Item no.: 209-701 WSB marking card; as card; not stretchable; plain; snap-on type; white	209-701
	Item no.: 209-701/000-002 WSB marking card; as card; not stretchable; plain; snap-on type; white	209-701 /000-002
	Item no.: 209-701/000-005 WSB marking card; as card; not stretchable; plain; snap-on type; white	209-701 /000-005
	Item no.: 209-701/000-006 WSB marking card; as card; not stretchable; plain; snap-on type; white	209-701 /000-006
	Item no.: 209-701/000-007 WSB marking card; as card; not stretchable; plain; snap-on type; white	209-701 /000-007
	Item no.: 209-701/000-012 WSB marking card; as card; not stretchable; plain; snap-on type; white	209-701 /000-012
	Item no.: 209-701/000-017 WSB marking card; as card; not stretchable; plain; snap-on type; white	209-701 /000-017
	Item no.: 209-701/000-023 WSB marking card; as card; not stretchable; plain; snap-on type; white	209-701 /000-023
	Item no.: 209-701/000-024 WSB marking card; as card; not stretchable; plain; snap-on type; white	209-701 /000-024

General accessories

	Item no.: 280-609 Terminal block for pluggable modules; 12-pole; with 4-conductor terminal blocks; with orange separator; for DIN-rail 35 x 15 and 35 x 7.5; 2.5 mm ² ; CAGE CLAMP®; 2,50 mm ² ; gray	280-609
	Item no.: 280-619 Terminal block for pluggable modules; 6-pole; with 2-conductor terminal blocks; with orange separator; for DIN-rail 35 x 15 and 35 x 7.5; 2.5 mm ² ; CAGE CLAMP®; 2,50 mm ² ; gray	280-619
	Item no.: 280-763 Terminal block for pluggable modules; 12-pole; with 4-conductor terminal blocks; with marker carrier; with orange separator; for DIN-rail 35 x 15 and 35 x 7.5; 2.5 mm ² ; CAGE CLAMP®; 2,50 mm ² ; gray	280-763



Downloads

Documentation

Bid Text

286-830 Interface-Bausteine mit Sonderfunktionen	Jan 15, 2016	doc 24.6 kB	Download
---	--------------	----------------	--------------------------

Additional Information

Disposal; Electrical and electronic equipment, Packaging	V 1.0.0	pdf 265.8 kB	Download
--	---------	-----------------	--------------------------

CAD/CAE - Smart Data

WSCAD

WSCAD Universe			Download
----------------	--	--	--------------------------

Subject to changes.
